

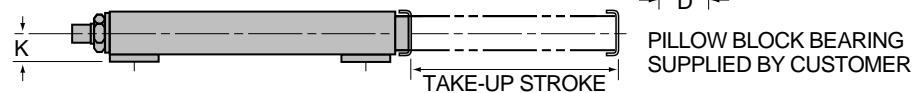

STANDARD TELESOPER® CONVEYOR BELT TAKE-UP

MILD STEEL AND STAINLESS STEEL MODELS
ALL STANDARD MODELS IN STOCK FOR IMMEDIATE SHIPMENT.

HOW TO SPECIFY AND ORDER							STANDARD TELESOPER® DIMENSIONS - ALL IN INCHES																	
BEARING BORE RANGE	TUBE SERIES	TAKE UP STROKE	MATERIAL	MTG. FEET	BEARING PLATE		BEARING PLATE DIMENSION						FOOT DIMENSION						SQ. TUBE SIZE		ADJUSTER			
2	3	4	5	6	7	LOA	K	A	B	C	D	N BOLT	E	F	G	H	I BOLT	Z	SLIDER	BODY	SQ. THD.	DRIVE UNC.		
1/2" to 1"	100	3	MS	SF	BP	6.88	.88	5.25	4.31	2.94	1.50	3/8	.75	3.56	2.63	3.69	1/2	1.84	1.00	1.25	3/8	5/8		
		6	SS		10.38									TO										
		9			14.38									11.00										
3/4" to 1 3/4"	250	3	MS	SF	BP	8.50	1.13	7.00	5.69	3.81	2.04	1/2	1.00	4.38	3.00	4.00	1/2	2.25	1.50	1.75	1/2	3/4		
		6	SS		11.50									TO										
		9			14.50									10.00										
1 3/4" to 2 15/16"	300	6	MS	SF	BP	11.13	1.50	10.00	8.69	5.56	2.84	5/8	1.25	6.12	4.00	5.25	5/8	2.63	2.25	2.50	1/2	7/8		
		9	SS		15.13									TO										
		12			19.13									9.00										
1 3/4" to 2 15/16"	350 HD	9	MS	SF	BP	19.00	1.75	10.00	8.69	5.56	3.00	5/8	1.25	13.00	4.50	5.75	5/8	3.50	2.50	3.00	PINNED NUT	7/8		
		12	SS		22.00									TO										
		18			28.00									6.00										
27/16" to 3 1/2"	400	12	MS	SF	BP	27.75	2.13	14.00	11.75	8.50	3.50	3/4	1.75	20	5.50	7.50	3/4	4.25	3.00	3.50	PINNED NUT	1 1/4		
		18	SS		33.75									TO										
		24			39.75									5.00										
3 11/16" to 6"	500	18	MS	SF	BP	41.38	3.50	BEARING PLATE BUILT PER CUSTOMER SPECIFICATIONS						2.50	31	9.00	11.50	1.00	6.50	5.00	6.00	PINNED NUT	2 1/4	
		24			47.38			TO																
		36			63.38			4.00																

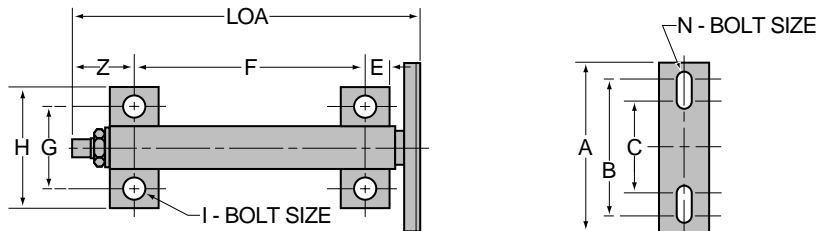

HOW TO SPECIFY AND ORDER						
BEARING BORE RANGE	TUBE SERIES	TAKE UP STROKE	MATERIAL	MTG. FEET	BEARING PLATE	
2	3	4	5	6	7	
1/2" to 1"	100	3	MS	SF	BP	
		6	SS			
3/4" to 1 3/4"	250	3	MS	SF	BP	
		6	SS			
1 3/4" to 2 15/16"	300	6	MS	SF	BP	
		9	SS			
1 3/4" to 2 15/16"	350 HD	9	MS	SF	BP	
		12	SS			
27/16" to 3 1/2"	400	12	MS	SF	BP	
		18	SS			
3 11/16" to 6"	500	18	MS	SF	BP	
		24				

How to Order

Standard Telescopers® Conveyor Belt Take-Up

- Select the Pillow Block you require for your application from the bearing manufacturers catalog. Note the bearing bore.
- Locate your Bearing Bore Range (Column one in dimension chart)
- Select corresponding "Tube Series"(Specify "300")
- Determine "Take-up Stroke" in inches(Specify "9")
- Select Material("MS" for mild steel, or "SS" for stainless steel)
- Specify Body Mounting Method("SF" for standard feet)
- Specify Bearing Plate("BP" for bearing plate)

Required ordering specification
300-9-MS-SF-BP

Availability of Options

Since the Telescop^{er}® is a modular design, most options can be combined. As an example, any of the bearing mounting options are available with any of the body mounting options. The same can be said for combining different body and bearing mounts with some of our performance options such as compression springs, hydraulics or Quick Release mechanisms. Also, most options are available in stainless or low carbon steel and may be plated, powder coated, wet process painted or left bare.

When designing a Telescop^{er}® for your application, you are advised to examine the entire spectrum of options available so as to maximize the utility of the Telescop^{er}® in your conveying environment.

Finally, all options are generally available, in any combination, within a one week lead time. For design assistance, option application information, production availability and pricing, please consult with your Bryant Sales Representative.

Telescop^{er}® Options

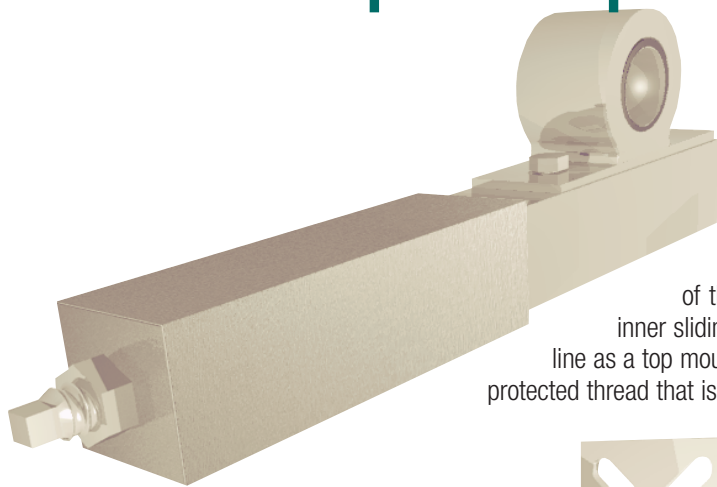

ES - Extended Slider

A design alternative to the "top mount" or "protected screw" type takeups. The Telescop^{er}® can be mounted to either the side of the conveyor or the top of the frame. We then extend the inner tube by the length of the base of the pillow block and the bearing is bolted to the top of the inner sliding tube. This allows the user to maintain the same center-line as a top mount takeup. And remember - only Telescop^{ers}® offer a truly protected thread that is guaranteed to perform - year after year after year ...

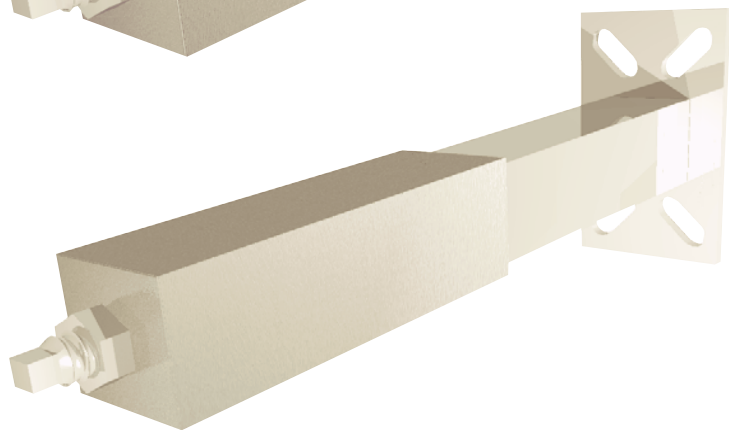

FB - Four Bolt Mount

A slotted bearing plate designed to accommodate a wide range of four bolt "E" Type bearings or you may order a bearing plate drilled to the specific bearing that you require. Either is readily available.

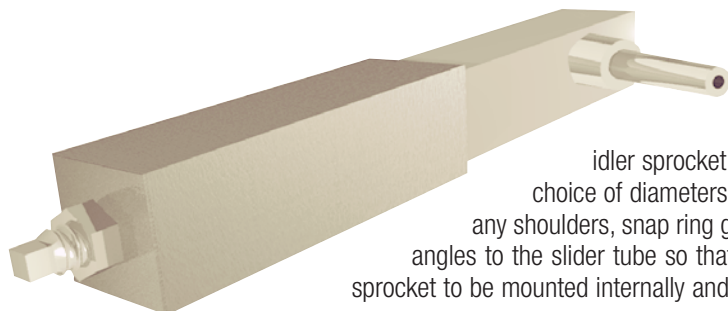

SH - Shaft Mount

With the growing use of Spring Compression Telescop^{ers}® in chain driven conveyor applications, the slider tube can be fitted with a shaft for mounting an idler sprocket or sheave. Like any precision shaft, you can specify your choice of diameters, OD tolerance, size and the location and configuration of any shoulders, snap ring grooves or threads. Typically the shaft is mounted at right angles to the slider tube so that the shaft projects into the conveyor frame allowing the sprocket to be mounted internally and in line with the chain flights.

Slider Options (continued)

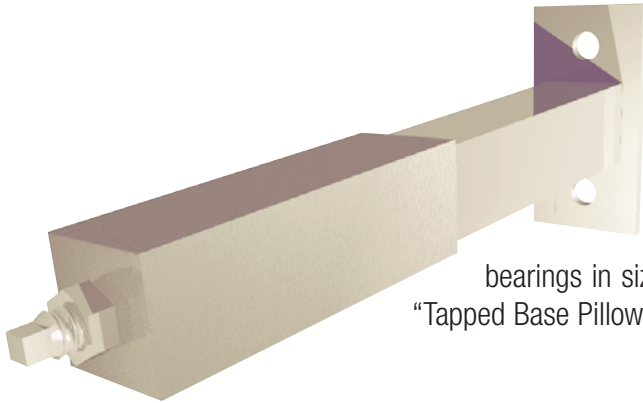

TPB - Tapped Base Pillow Block

Stock mounts are available in five sizes spanning 100 and 250 series takeups in low carbon and stainless steel. These mounts are externally sized and drilled to fit all manufacturer's pillow block bearings in sizes from 1/2" to 2 1/4" bores. For more information, see section on "Tapped Base Pillow Blocks" on page 25.

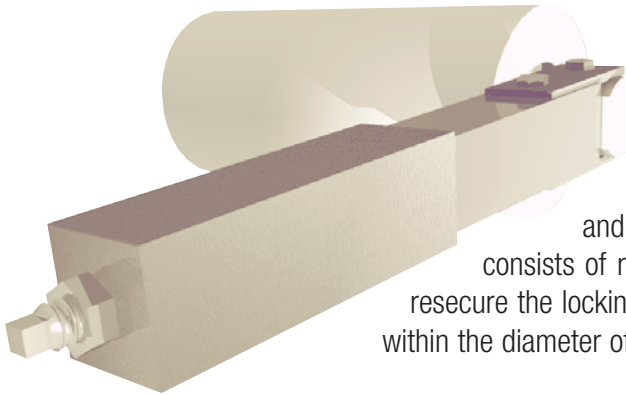

MP - Motorized Pulley

Motorized Pulley Mounts - made specifically for all makes of motorized pulleys - this low profile design is fitted for the shaft size and locks against the opposing flats milled into the pulley shaft. Mounting consists of removing two bolts and the locking top plate, drop in the pulley and resecure the locking plate and bolts. The low profile of this design is entirely contained within the diameter of the pulley.

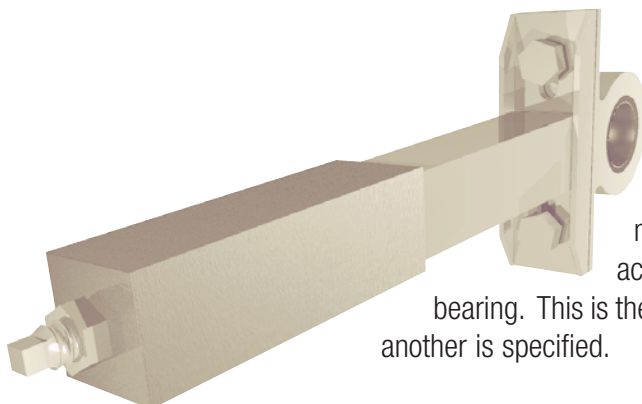

BP - Bearing Plate

Bearing Plate - all standard Telescopers[®] are fitted with a slotted mounting plate for two bolt pillow block bearings. This easily accessible mount permits rapid mounting and change over of the bearing. This is the **Standard Bearing Mounting** for all Telescopers[®] unless another is specified.

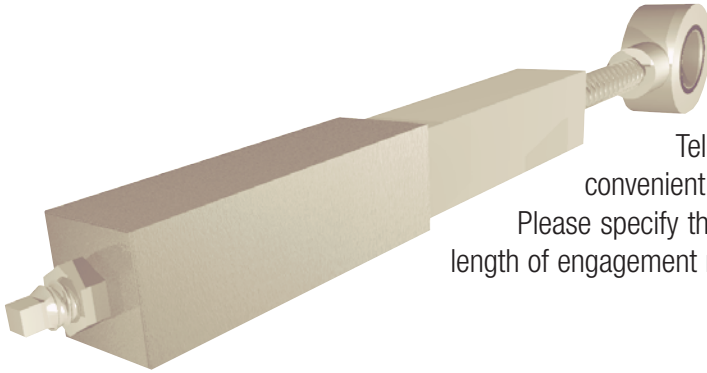

MT - Male Thread

Telescopers[®] can be fitted with male threads for convenient mounting of hanger bearings or rod ends. Please specify the thread required - pitch and diameter plus the length of engagement needed.

Performance Options



GF - Grease Fitting

The optional grease fitting may be the single most useful option when operating Telescopers[®] in heavily contaminated or wet environments. Installation and proper use of a grease fitting extends the standard Two Year Warranty to a full Five Year No-Freeze Up Warranty assuring you of five years adjustment in any operating environment. The grease fitting is installed in the slider tube at the factory as a same day delivery installed option. In addition to the grease fitting, internal ports are formed into the slider tube. Once the slider tube is filled with grease, a slight addition of more grease allows the grease to flow from the cavity of the slider tube into the interface between the slider and body tubes.



PN - Pinned Nut

An optional pinned nut is available when greater adjustment torques are required. The broader hex surface of the pinned nut offers more contact area and is therefore capable of withstanding higher torque and is more resistant to rounding off than the standard square drive intended for medium and light duty applications. The pinned nut is standard on the 350, 400 and 500 series Telescopers[®] and optional on the 100, 250 and 300 series. When installed as an option it is generally available for same day shipment.

Performance Options (continued)

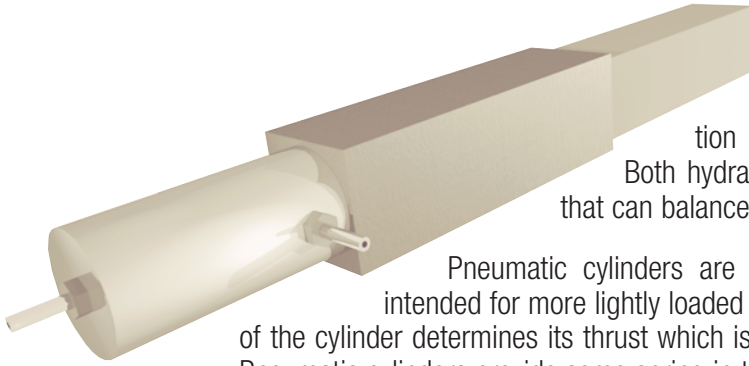

LA - Linear Actuator

The standard method for adjusting all Telescopers[®] models is a threaded adjuster rod, however we offer linear actuation of the Telescopers[®] via hydraulic or pneumatic cylinders. Both hydraulics and pneumatics offer remote actuation and systems that can balance and synchronize the movement of takeups simultaneously.

Pneumatic cylinders are mounted to the exterior of the Telescopers[®]. They are intended for more lightly loaded applications and offer a variety of diameters. The diameter of the cylinder determines its thrust which is rated as a multiple of the air line pressure of your facility. Pneumatic cylinders provide some spring in the takeups since the air compresses. This will also provide automatic takeup which helps to maintain constant belt tension as the belt stretches.

Hydraulic actuation is available on our heavier duty Telescopers[®] - the 300, 350, 400 and 500 Series. Featuring a cylinder designed and built by us specifically for conveyor tensioning and tracking. Unique to our design only, we offer the hydraulic power that fits within the takeup. The cylinder is completely enclosed within the slider tube, is protected from the elements and makes for a more compact, durable unit. For more information on Hydraulic Telescopers[®], refer to the section on page 9.

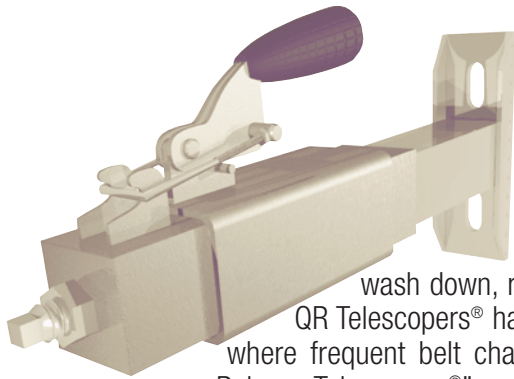

QR - Quick Release

Quick Release Telescopers[®] feature a third tube and a toggle clamp release mechanism that moves the entire Telescopers[®] forward and back while maintaining the original adjustment settings for tension and tracking. Primarily used in food processing applications, the QR Telescopers[®] can reduce wash down time from over 30 minutes to five. Release the clamp, slacken the belt, wash down, reset the clamp and immediately return the takeups to their original position.

QR Telescopers[®] have also been used to slacken belts in oven applications and in environments where frequent belt changes are necessary. For more information, refer to the section on "Quick Release Telescopers[®]" on page 21.

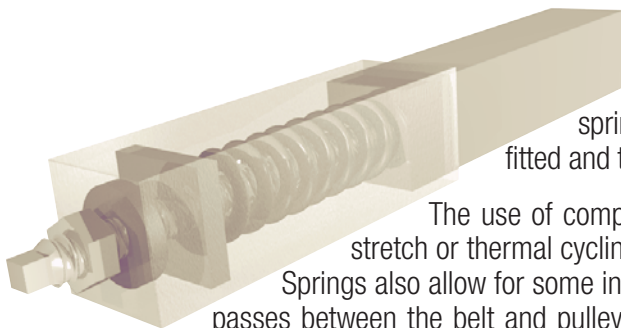

SC - Spring Compression

Any series of Telescopers[®] can be fitted with internal compression springs. Although generally used in compression, an external spring can be fitted and the SC Telescopers[®] can be mounted in tension at a reduced load rating.

The use of compression springs provide automatic takeup for belt or chain wear and stretch or thermal cycling of the belt - reducing conveyor maintenance and adjustment needs. Springs also allow for some ingestion of debris on the return run of the belt by "giving" as the debris passes between the belt and pulley face. Springs are ideal for main chain driven conveyor applications such as chain driven live roller unit handling conveyors and on the chain flights of drag conveyors and bucket elevators. For more information on the Spring Compression Telescopers[®], refer to the section on page 15.

Body Mounting Options

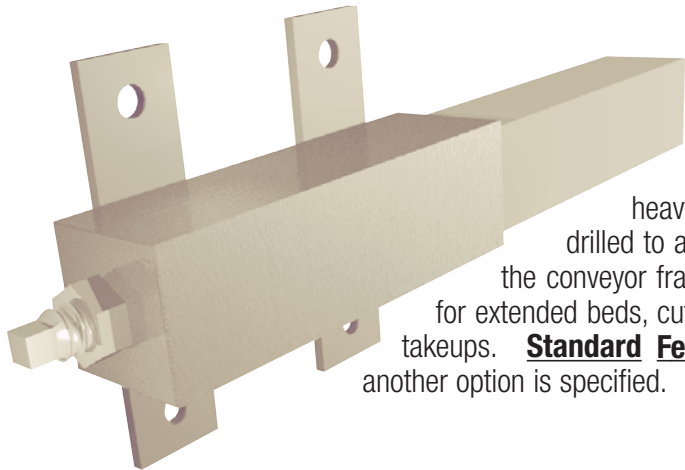

SF - Standard Feet

The standard takeup to frame mounting system for all stock Telescopers® consists of two heavy gage stamped mounting feet. The feet are drilled to allow easy mounting with four bolts to the side of the conveyor frame. This mounting method eliminates the need for extended beds, cutting, slotting and fitting associated with ordinary takeups. **Standard Feet are provided** with all Telescopers® unless another option is specified.

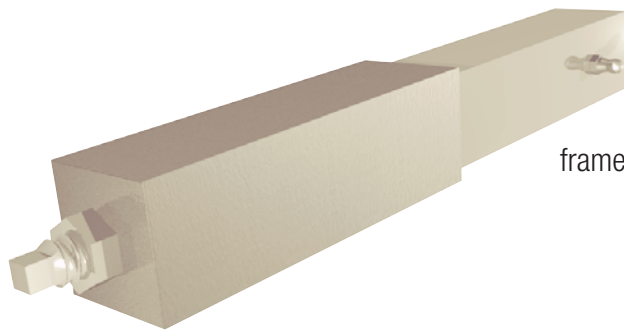

DW - Direct Weld

The body is not fitted with any mounting feet or studs. The body is welded directly to the conveyor frame providing a very low profile and secure mounting.

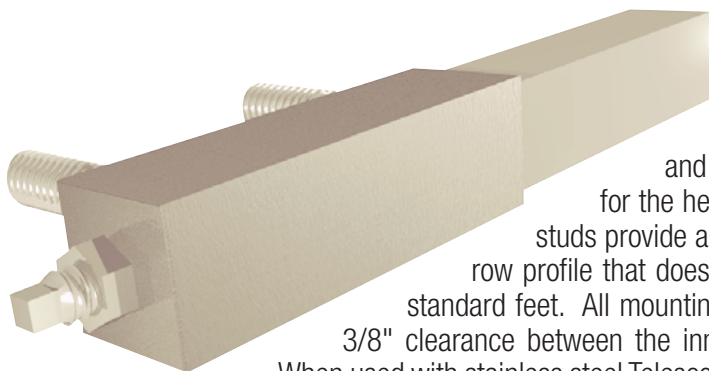

SM - Stud Mount

Mounting studs are welded to the rear face of the body tube, two studs in the case of 100 and 250 Series and four studs for added strength for the heavier duty 300, 350 and 400 Series. Mounting studs provide a fast method of mounting to the frame in a narrow profile that does not extend beyond the body tube as does the standard feet. All mounting studs are shouldered, providing from 1/8" to 3/8" clearance between the inner face of the body and the conveyor frame. When used with stainless steel Telescopers®, this standoff distance allows for pressure washing between the takeup and the conveyor frame.